

Código	Acabamento
21630	Zincado
31630	Bicromatizado
61630	Cromatizado Preto

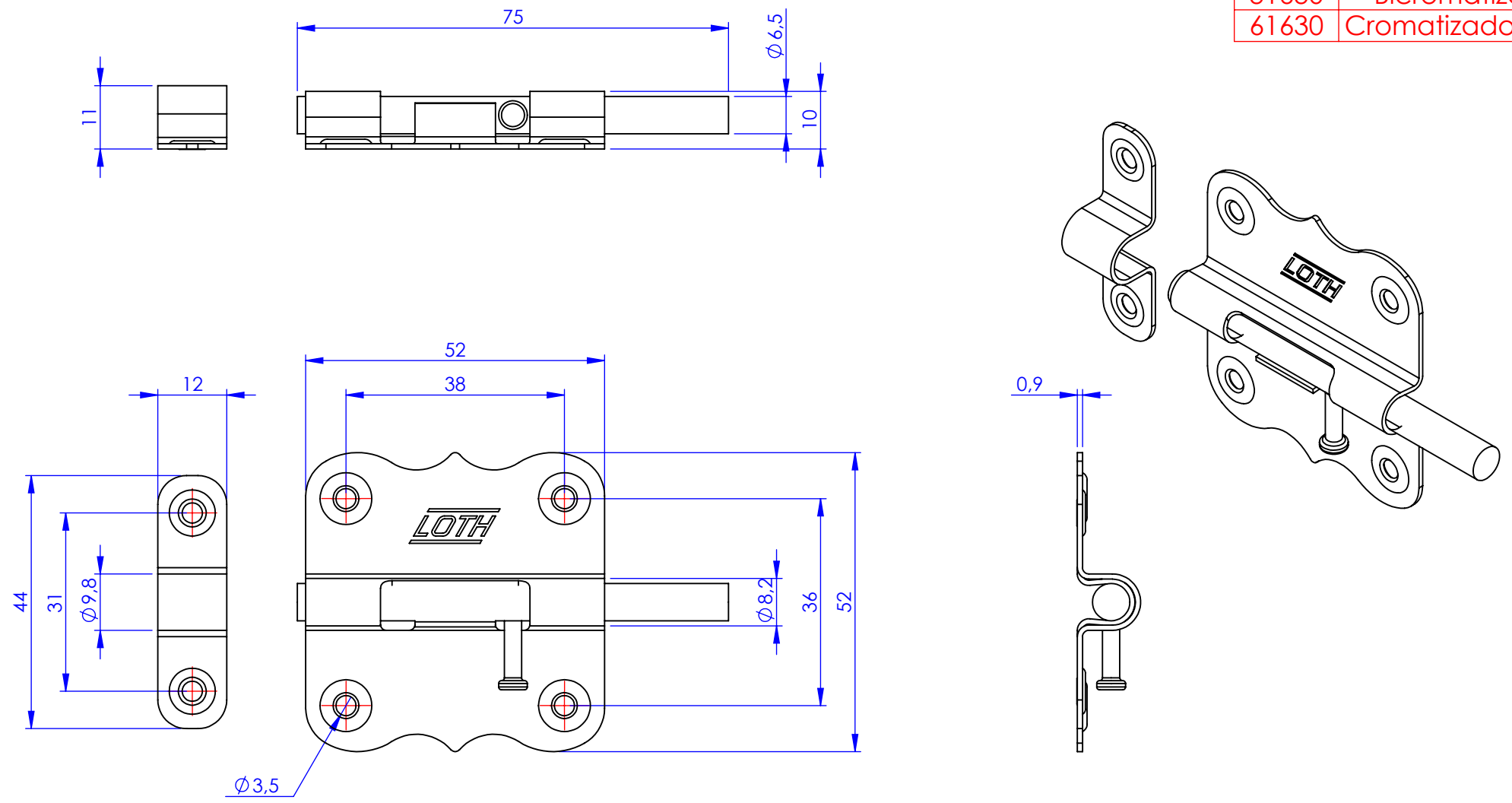

Metalúrgica Loth Ltda.	Cód.	1630
	Material:	AISI 1010
1630-Targeta 3,0pol	Peso:	46.04g
		