

Código	Acabamento
22140	Zincado
32140	Bicromatizado
62140	Cromatizado Preto
92140	Aço Inoxidável

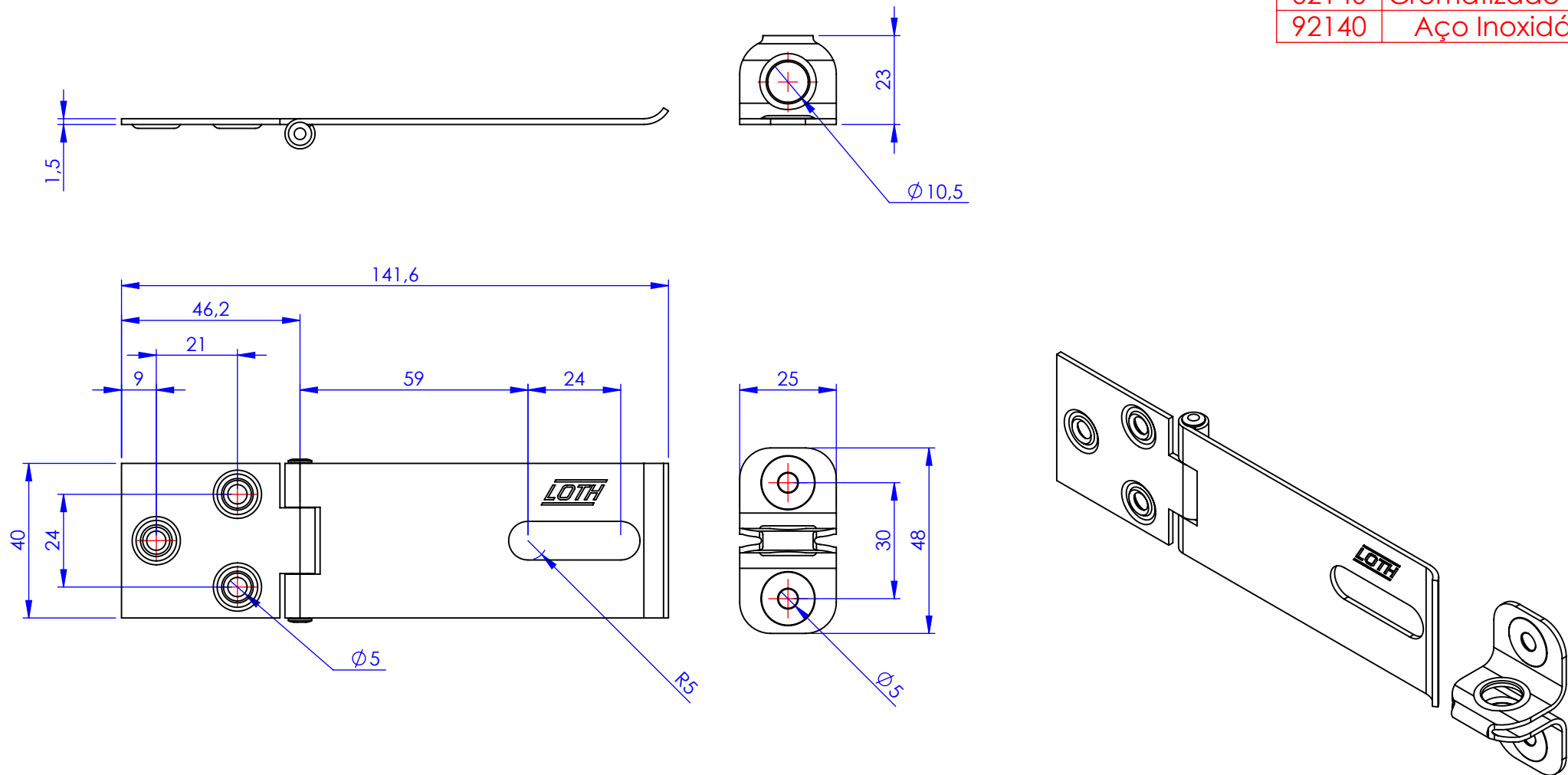

Metalúrgica Loth Ltda.

Cód. 2140

2140-Porta Cadeado 4,0

Material: AISI 1010

Peso: 94.77g

Porta Cadeado 4,0

