

Código	Acabamento
20960	Zincado
30960	Bicromatizado
60960	Cromatizado Preto

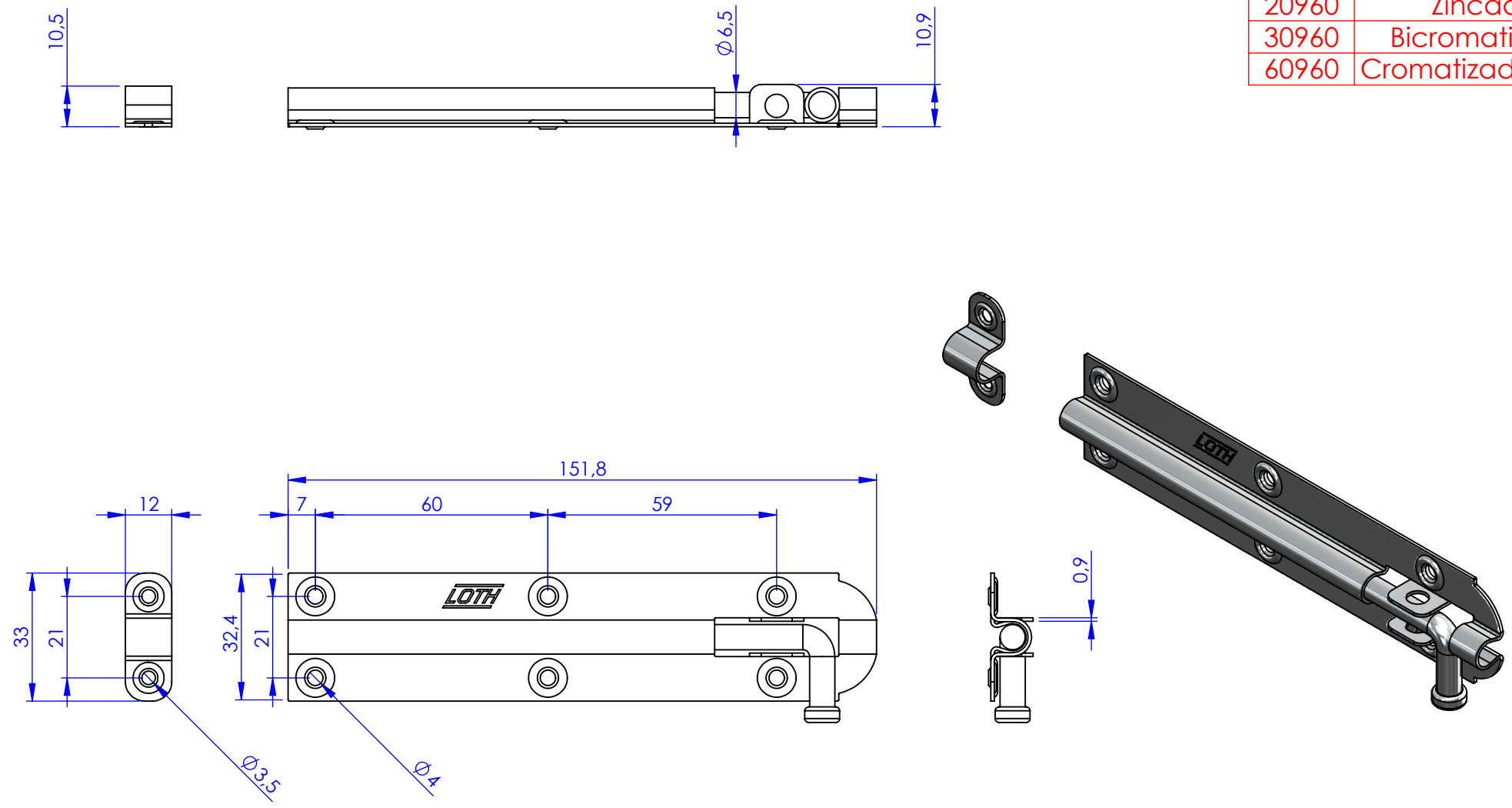

Metalúrgica Loth Ltda.	Cód.	0960
	Material:	AISI 1010
0960-Ferrolho 6,0	Peso:	91.87g
		