

Código	Acabamento
20940	Zincado
30940	Bicromatizado
60940	Cromatizado Preto

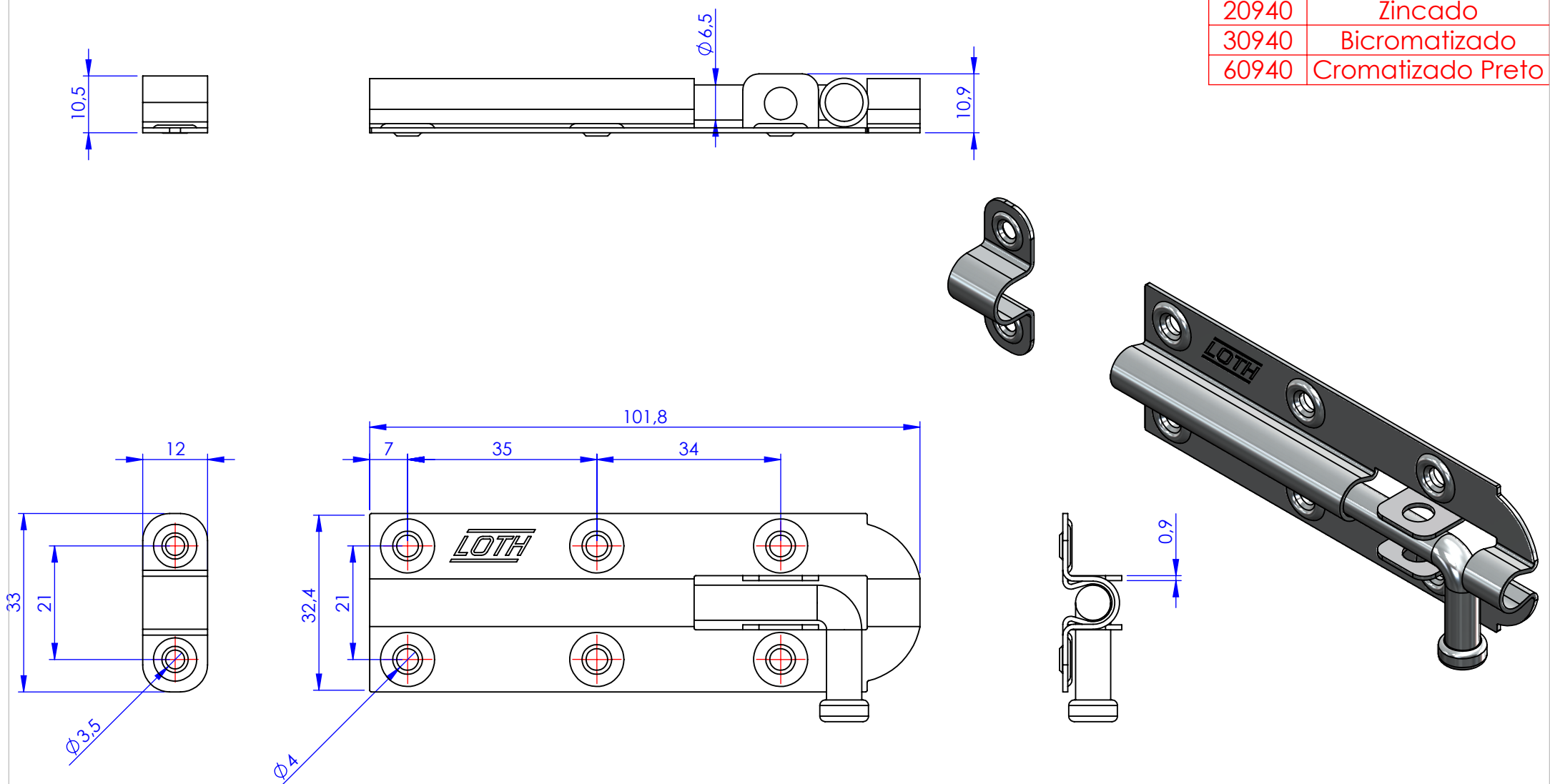

Metalúrgica Loth Ltda.	Cód.	0940
	Material:	AISI 1010
0940-Ferrolho 4,0	Peso:	62.44g
		