

Código	Acabamento
20560	Zincado
30560	Bicromatizado
60560	Cromatizado Preto

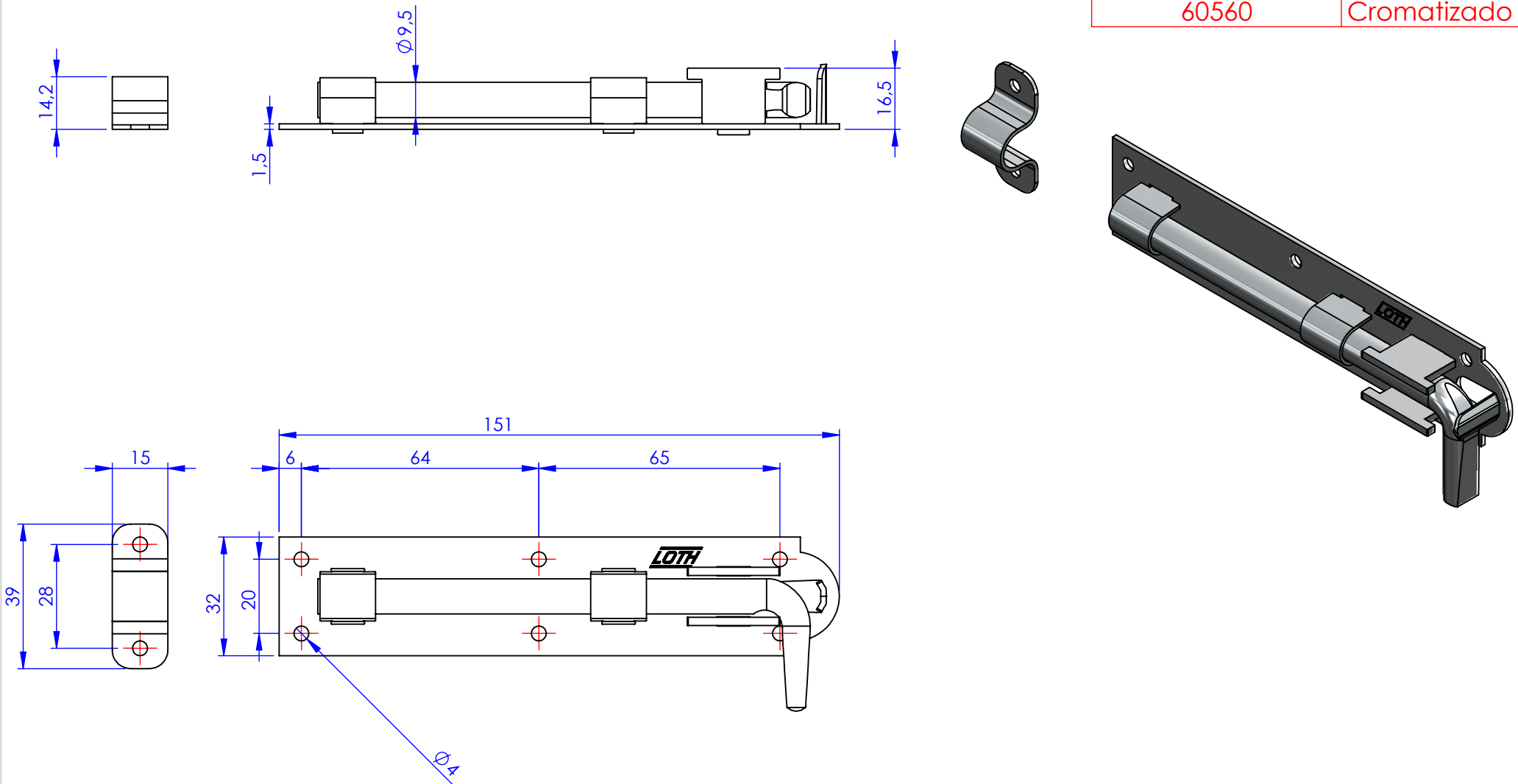

**Metalúrgica Loth Ltda.**

**0560-Ferrolho Fio Redondo 6,0**

Cód. 0560

Material: AISI 1010

Peso: 163.12g

