

Código	Acabamento
20830	Zincado
30830	Bicromatizado
60830	Cromatizado Preto

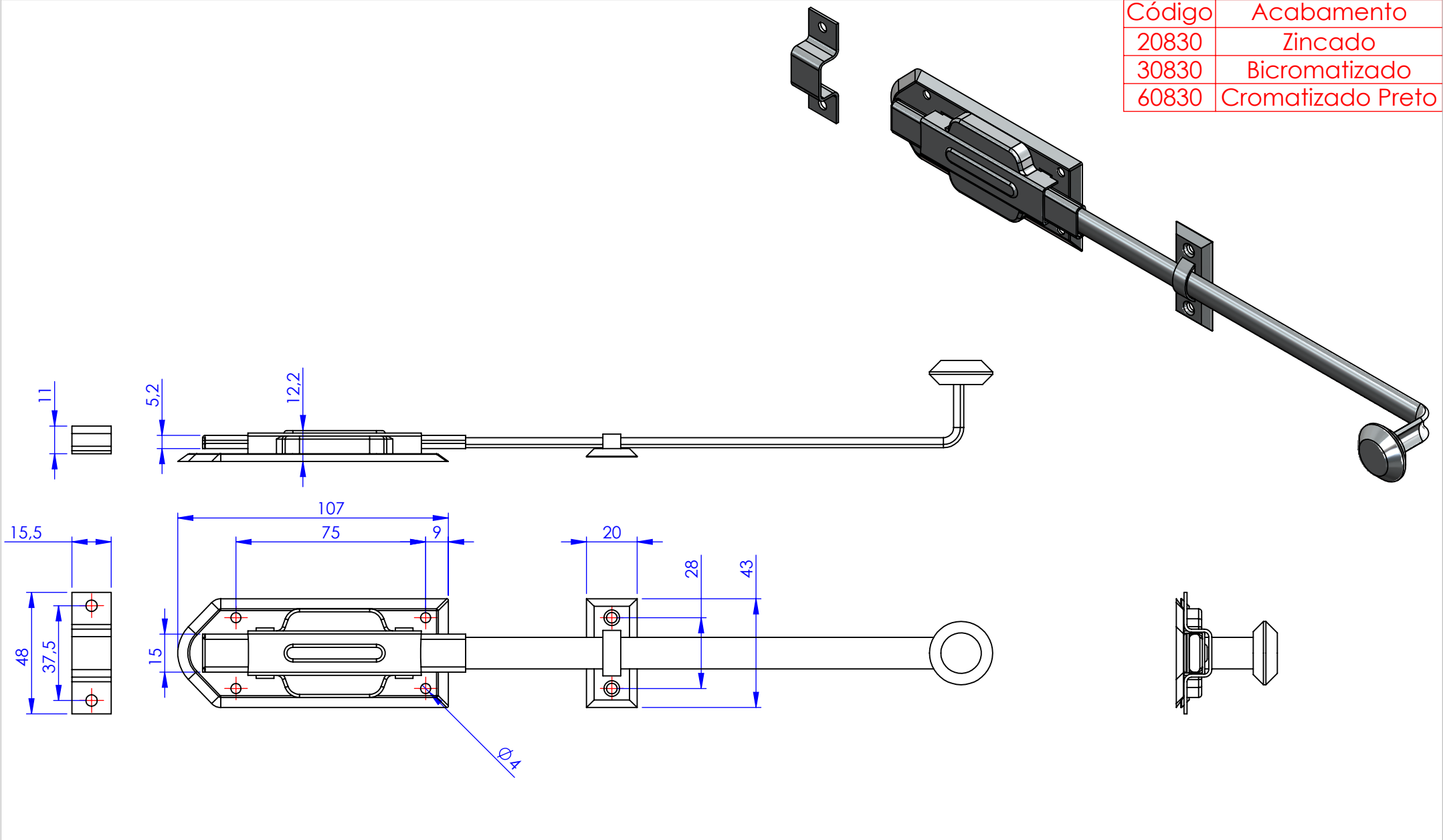

Metalúrgica Loth Ltda.	Cód.	0830
	Material:	AISI 1010
0830-Ferrolho Mola 30cm	Peso:	176.27g
		