

Código	Acabamento
20440	Zincado
30440	Bicromatizado
60440	Cromatizado Preto

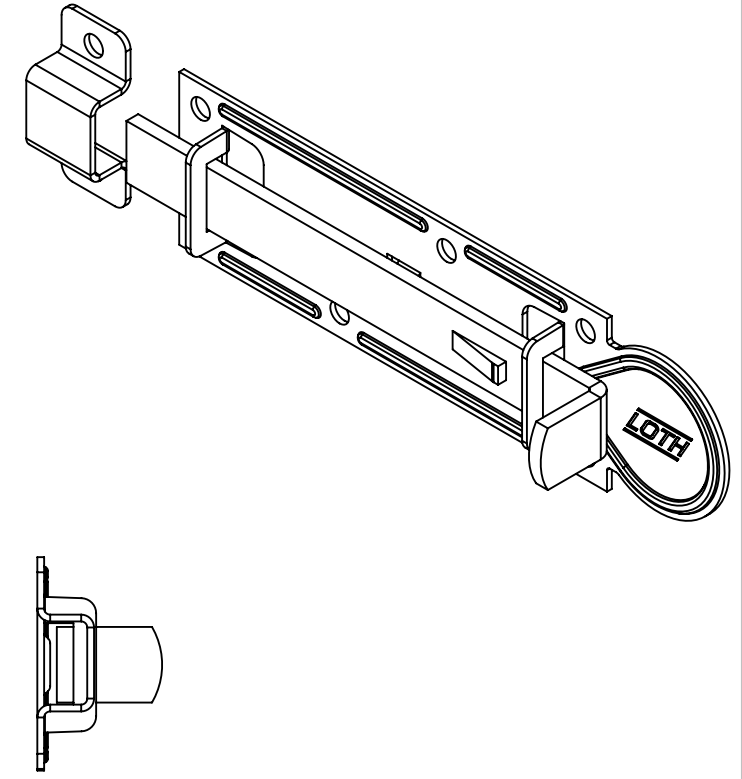
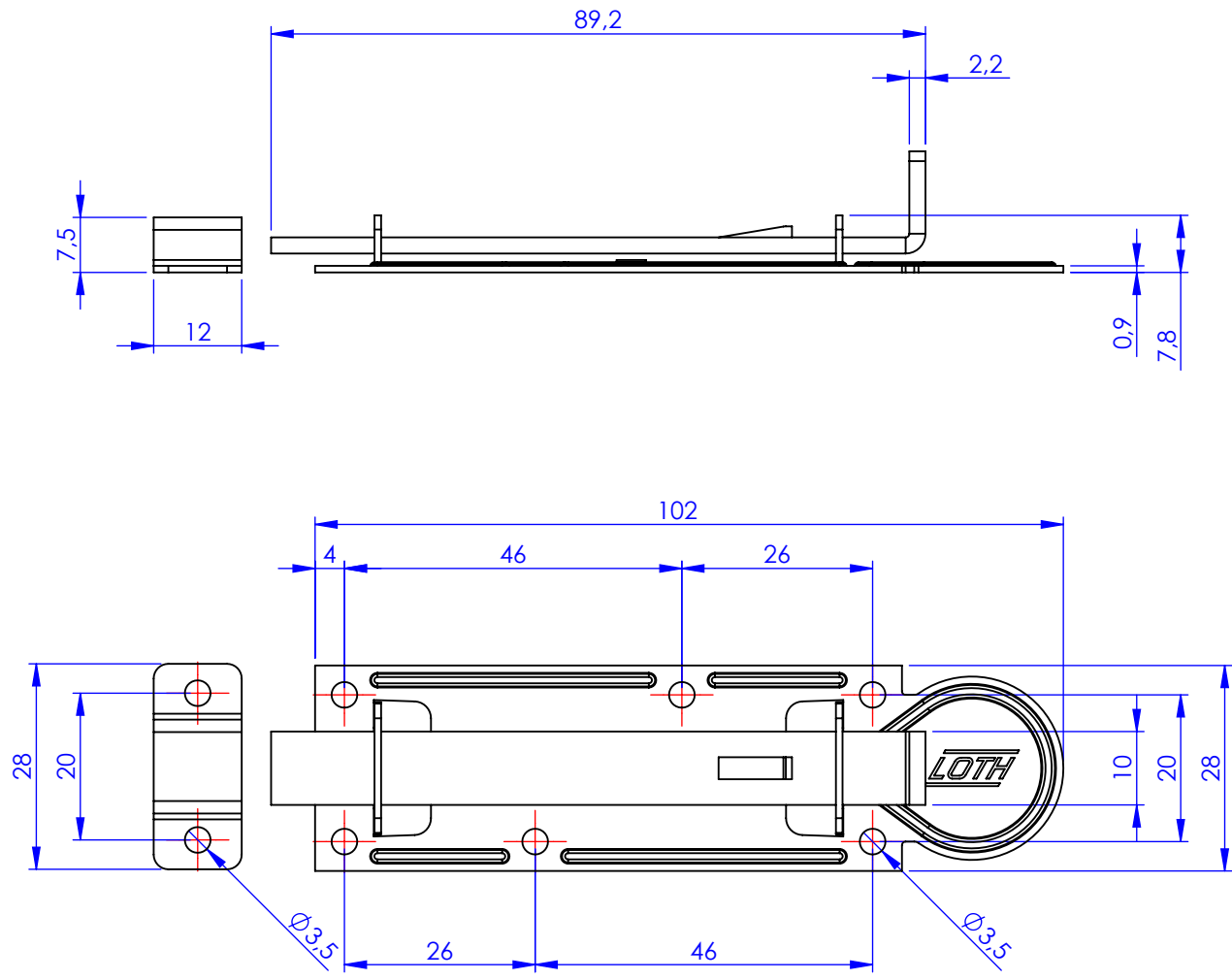

Metalúrgica Loth Ltda.	Cód.	0440
	Material:	AISI 1010
0440-Ferrolho Chato Tipo Leve LOTH 4,0	Peso:	38.29g
Ferrolho Chato Tipo Leve 4,0		