

Código	Acabamento
24012	Zincado
34012	Bicromatizado
64012	Cromatizado Preto

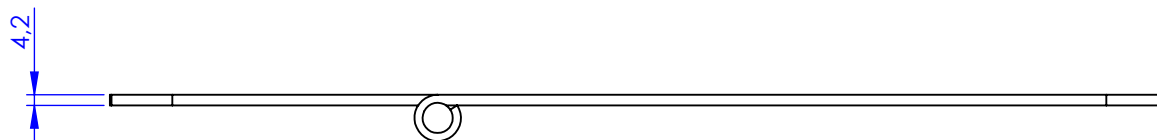
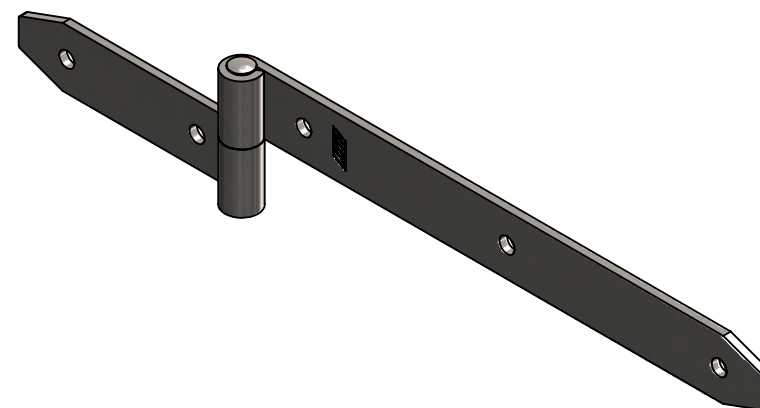

Metalúrgica Loth Ltda.

4012-Dobradica Portao Estreita 12pol Parafusar

Cód. 4012

Material: AISI 1010

Peso: 556.06g

