

Código	Acabamento
24706	Zincado
34706	Bicromatizado
64706	Cromatizado Preto

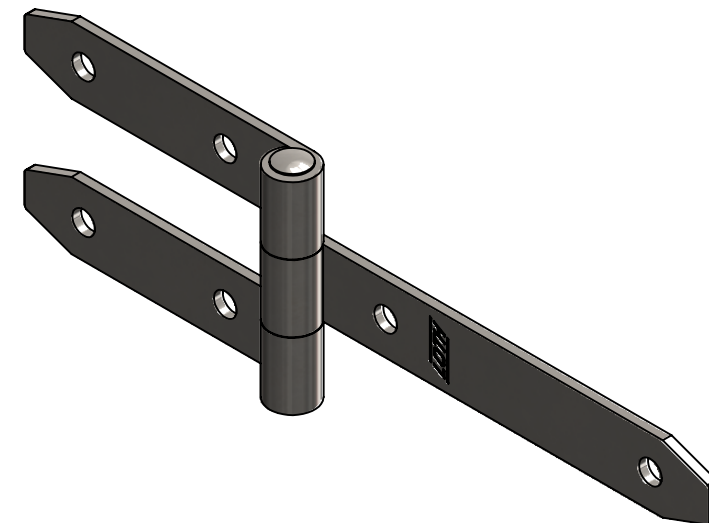
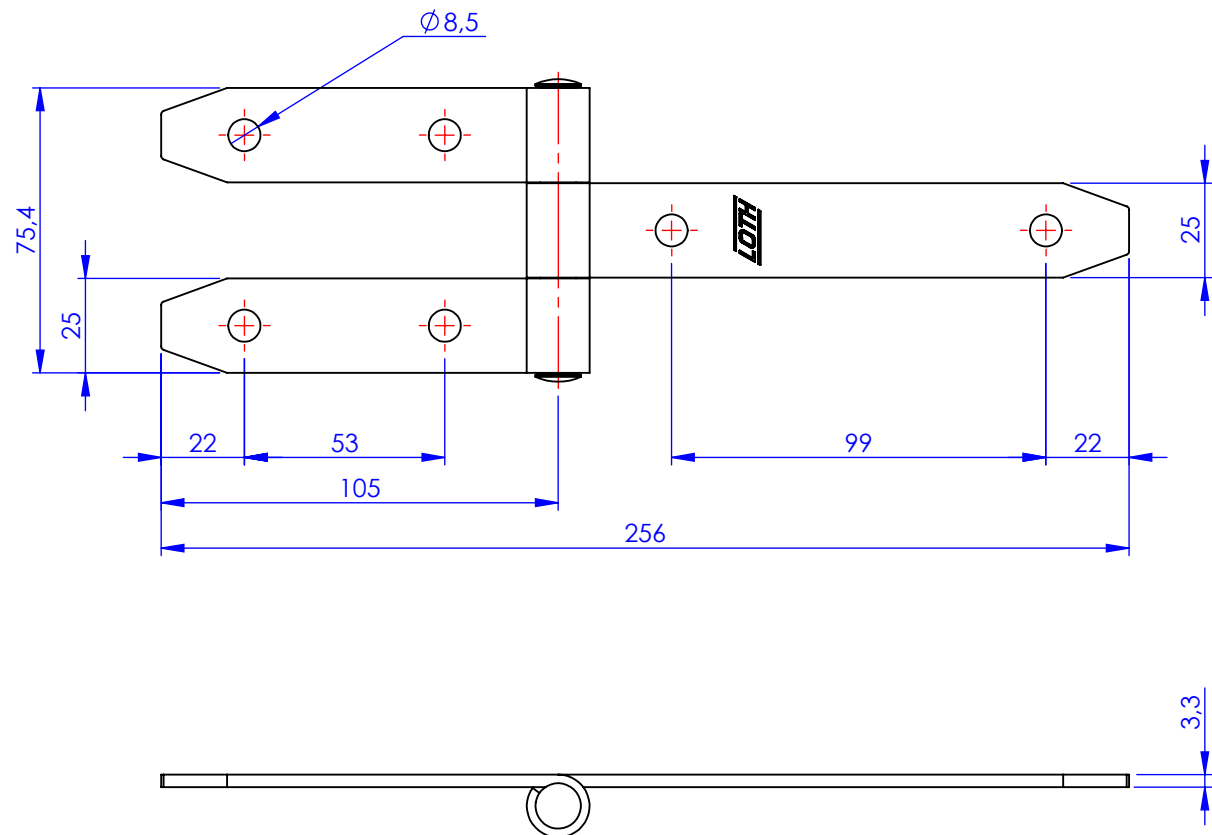

Metalúrgica Loth Ltda.

4706-Dobradica Portao Duas Hastes 6pol Parafusar

Cód. 4706

Material: AISI 1010

Peso: 330.63g

