

Código	Acabamento
24710	Zincado
34710	Bicromatizado
64710	Cromatizado Preto

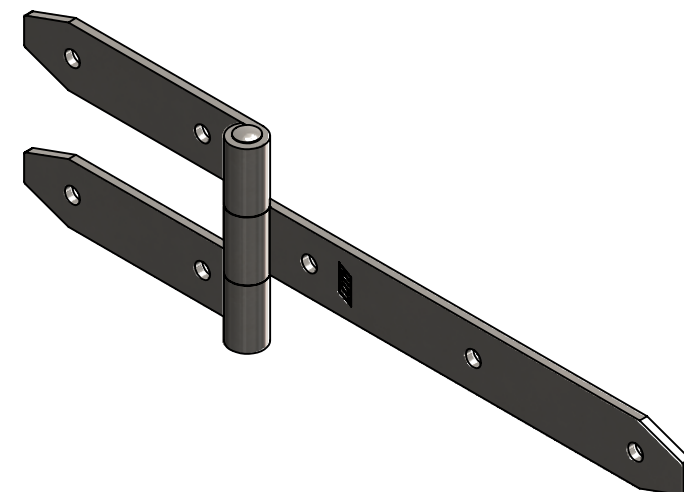
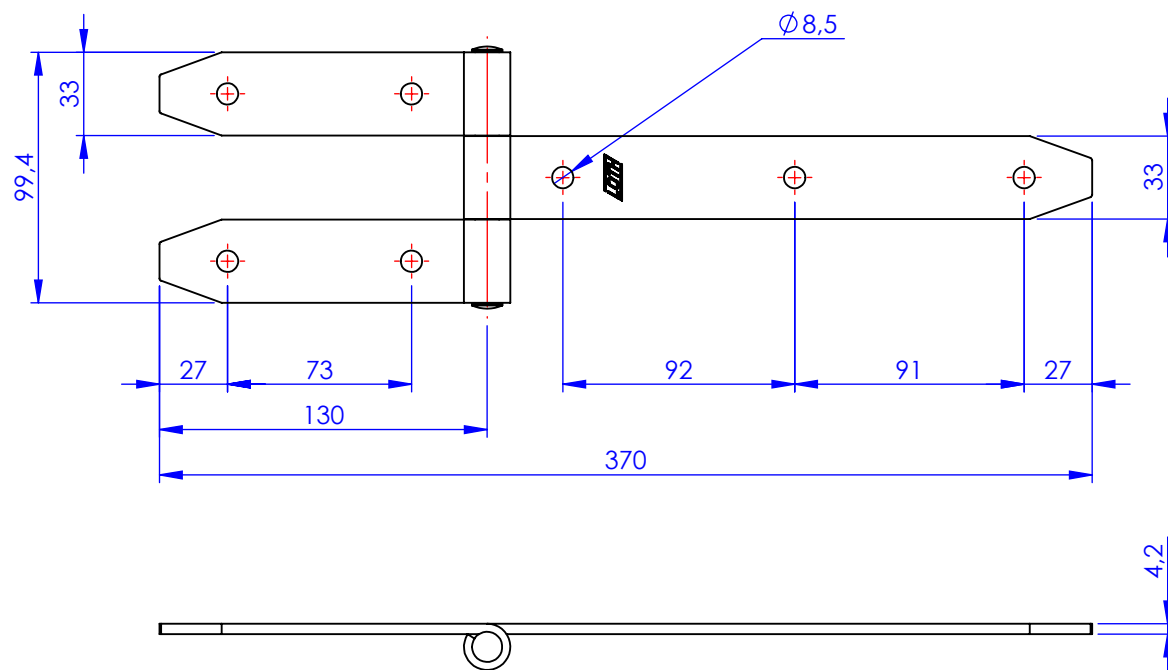

Metalúrgica Loth Ltda.

4710-Dobradica Portao Duas Hastes 10pol Parafusar

Cód. 4710

Material: AISI 1010

Peso: 691.21g

