

Código	Acabamento
3705	Pintado Epoxi Branco
23705	Zincado
33705	Bicromatizado
63705	Cromatizado Preto

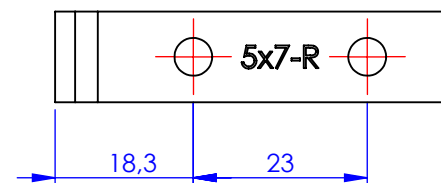
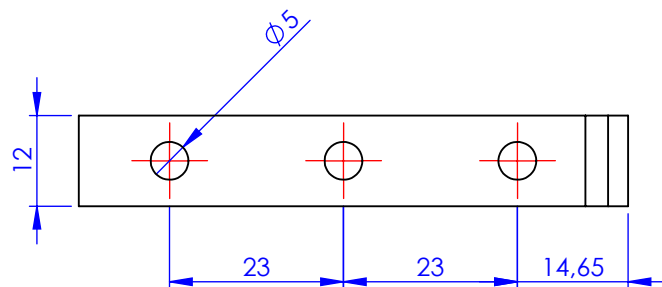
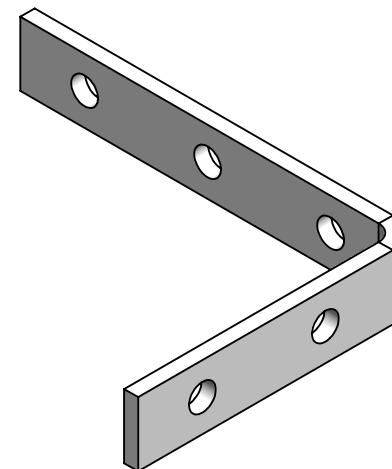
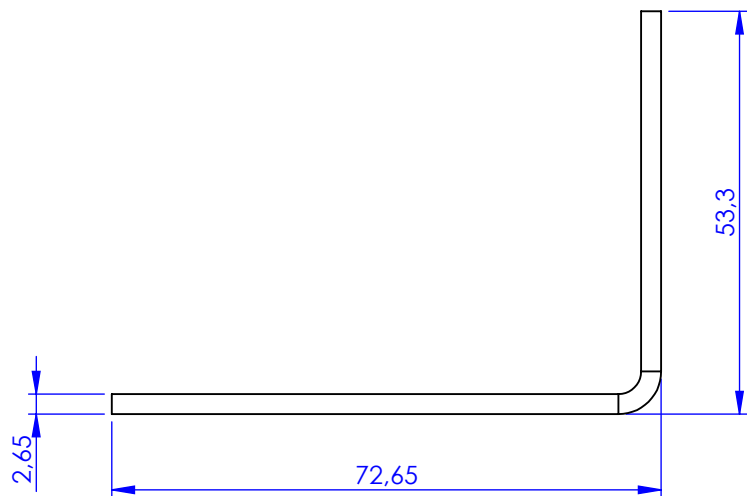

<b>Metalúrgica Loth Ltda.</b>	Cód.	3705	
	3705-Cantoneira Cortina Tipo Leve 5x7	Material:	AISI 1010
		Peso:	28.33g