

Código	Acabamento
3025	Pintado Epoxi Branco
23025	Zincado
33025	Bicromatizado
63025	Cromatizado Preto

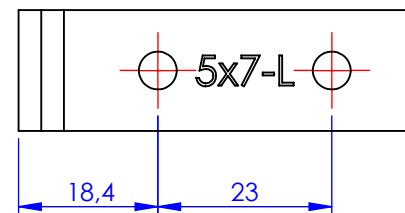
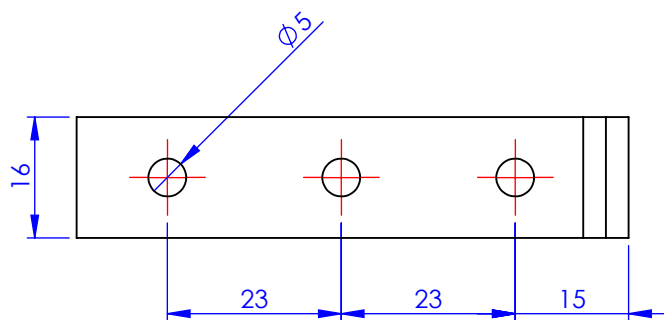
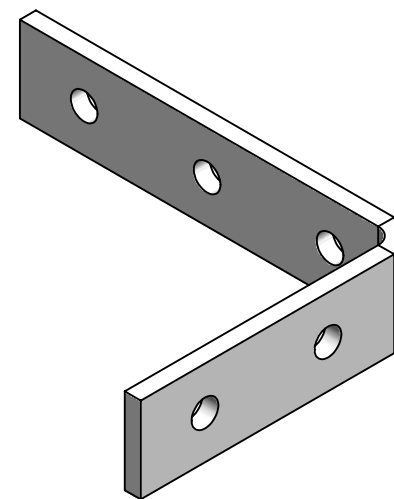
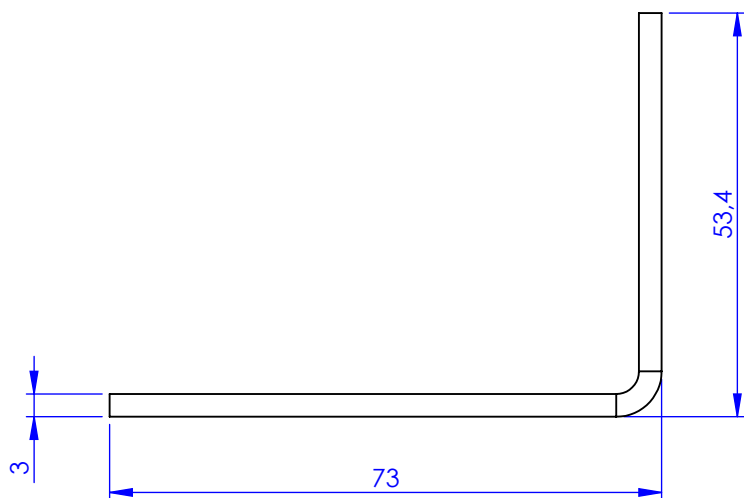

Metalúrgica Loth Ltda.

Cód. 3025

3025-Cantoneira Cortina 5x7

Material: AISI 1010

Peso: 43.55g

