

Código	Acabamento
3423	Pintado Epoxi Branco
23423	Zincado
33423	Bicromatizado
63423	Cromatizado Preto

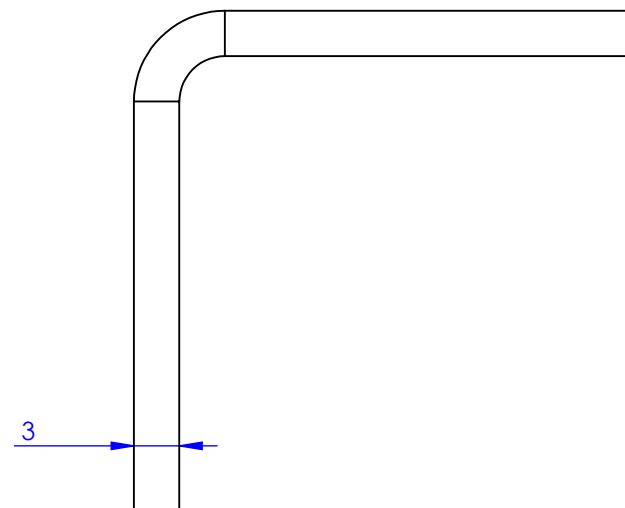
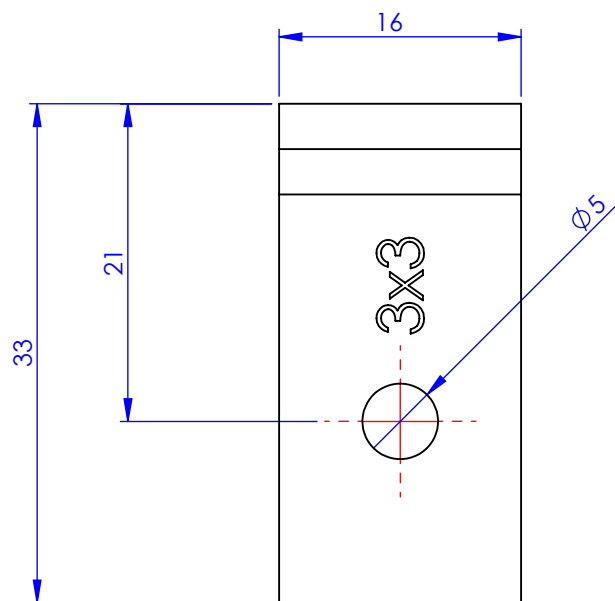
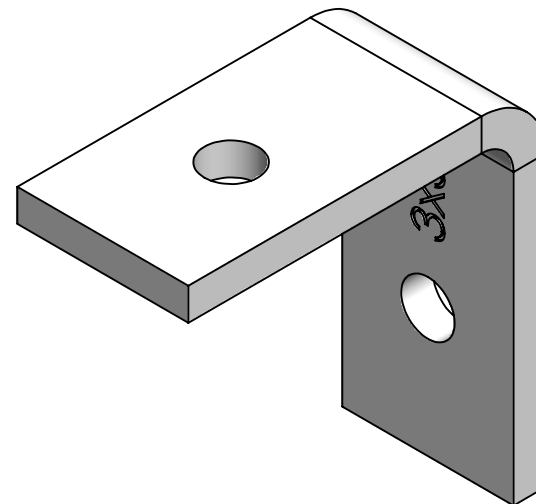
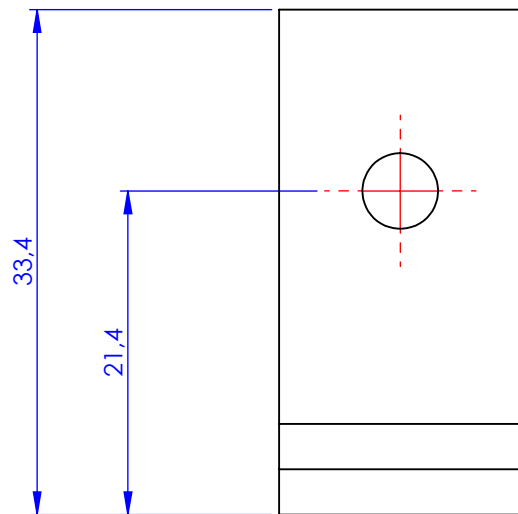

Metalúrgica Loth Ltda.

Cód. 3423

3423-Cantoneira Cortina 3x3

Material: AISI 1010

Peso: 22.29g

