

Código	Acabamento
5130	Polido
25130	Zincado
35130	Bicromatizado
65130	Cromatizado Preto
105130	F.L.O

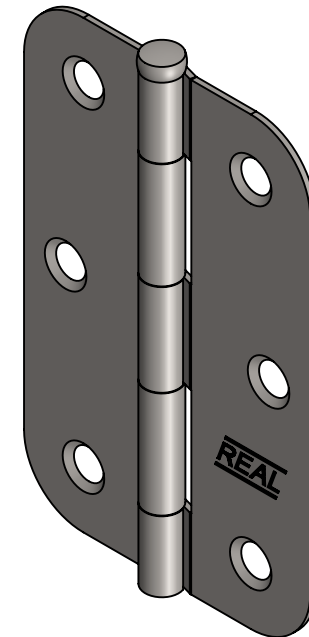

Metalúrgica Loth Ltda.

5130 - Dobradiça Pino Solto REAL Redonda 3,0

Cód. 5130

Material: AISI 1006-1008

Peso: 33.88g



LOTH