

Código	Acabamento
20387	Zincado
30387	Bicromatizado
60387	Cromatizado Preto

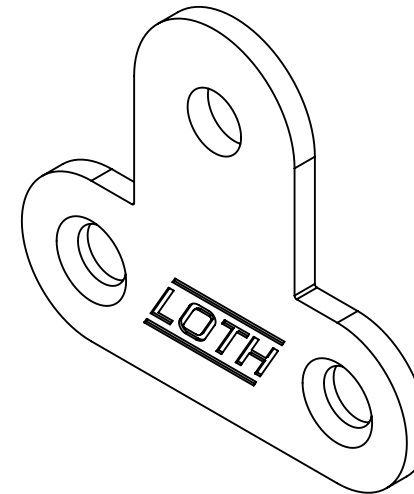
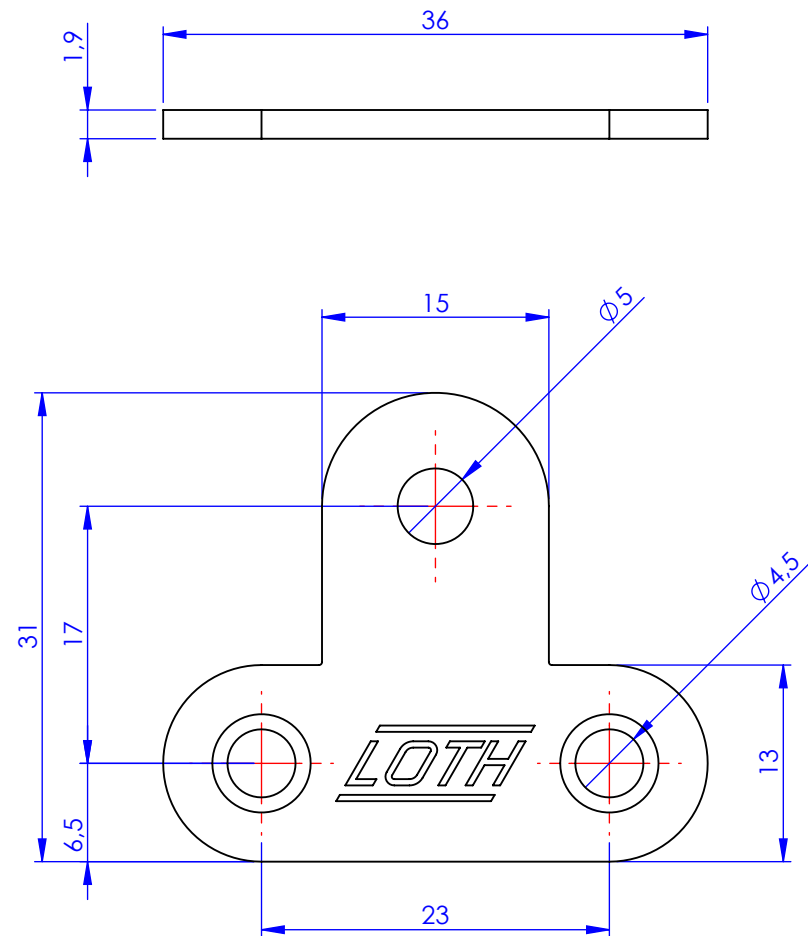

**Metalúrgica Loth Ltda.**

**0387-Prendedor Armario**

Prendedor Armario

Cód. 0387

Material: AISI 1010

Peso: 9.20g

