

Código	Acabamento
20385	Zincado
30385	Bicromatizado
60385	Cromatizado Preto

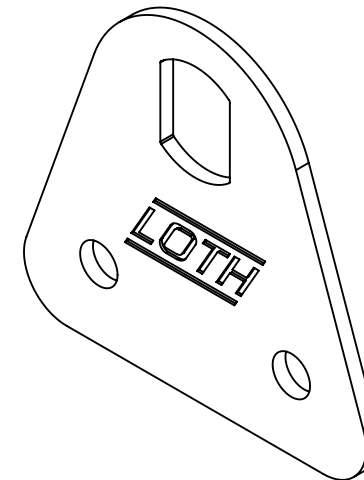
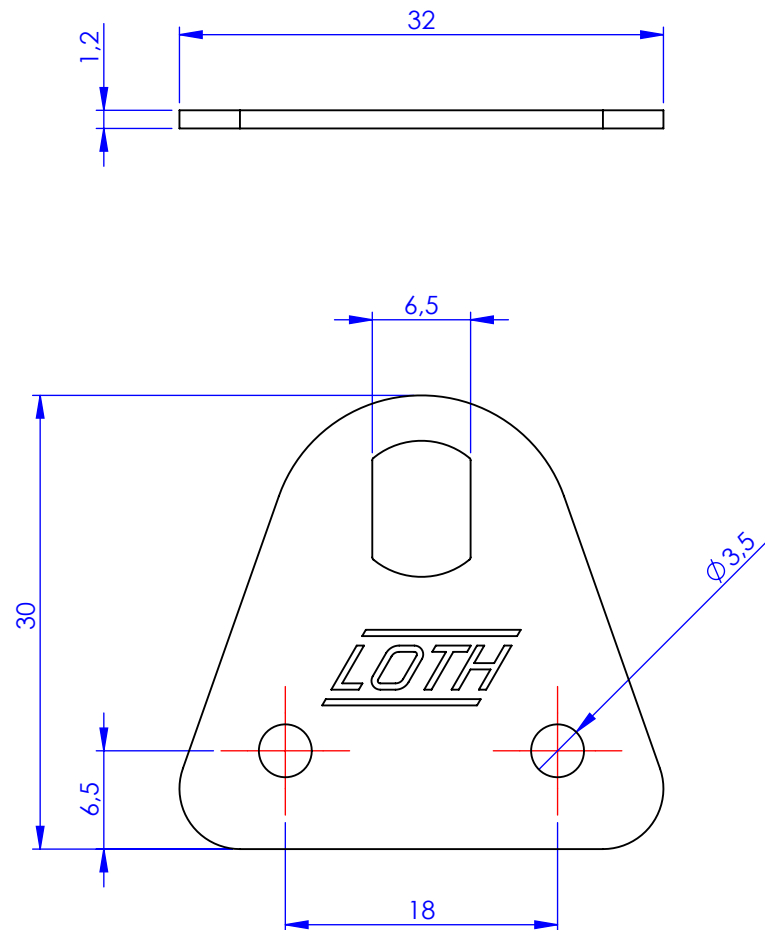

**Metalúrgica Loth Ltda.**

Cód. 0385

**0385-Prendedor Armario**

Material: AISI 1010

Peso: 5.98g

Prendedor Armario

