



440E.E42M12.C50-PP

BROCA 40mm

ATENDE A NORMAL NBR 14913

*Medidas em mm

Cilíndro 50mm

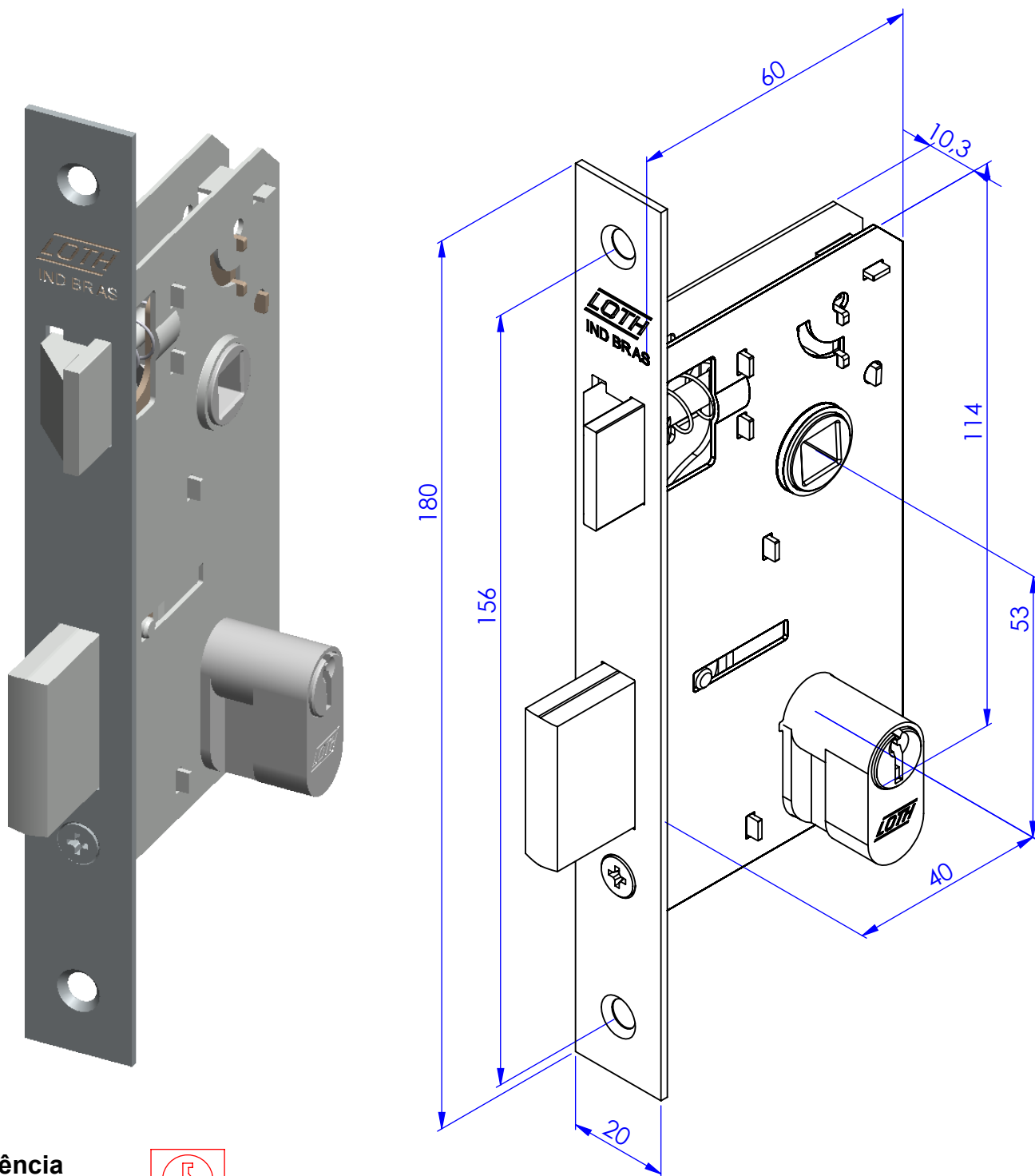

Referência

Matéria Prima

Aço ABNT 1010

Zamac

Aço Inox

Latão

Plástico de Engenharia

