

Código	Acabamento
23320	Zincado
33320	Bicromatizado
63320	Cromatizado Preto

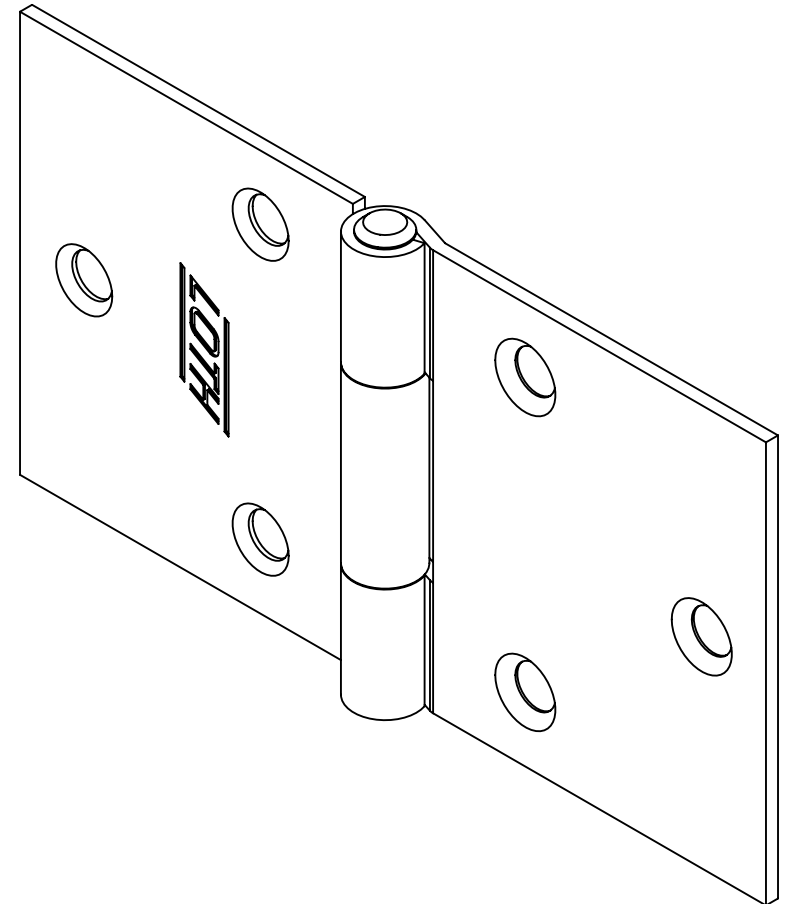
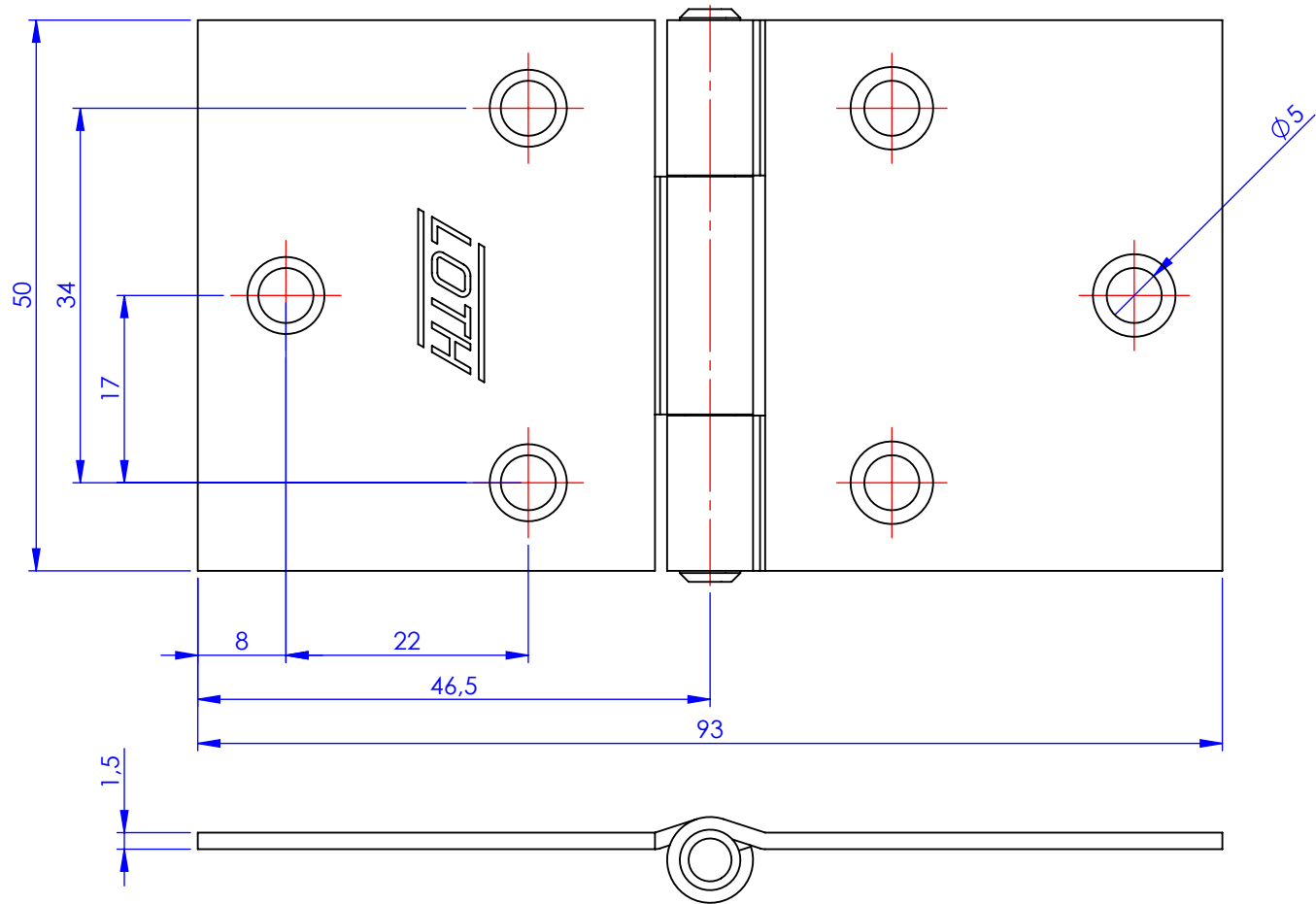

Metalúrgica Loth Ltda.

Cód. 3320

3320-Dobradica Quadrada 2,0

Material: AISI 1010

Peso: 65.94g

Dobradiça Quadrada 2,0

