

Código	Acabamento
23315	Zincado
33315	Bicromatizado
63315	Cromatizado Preto

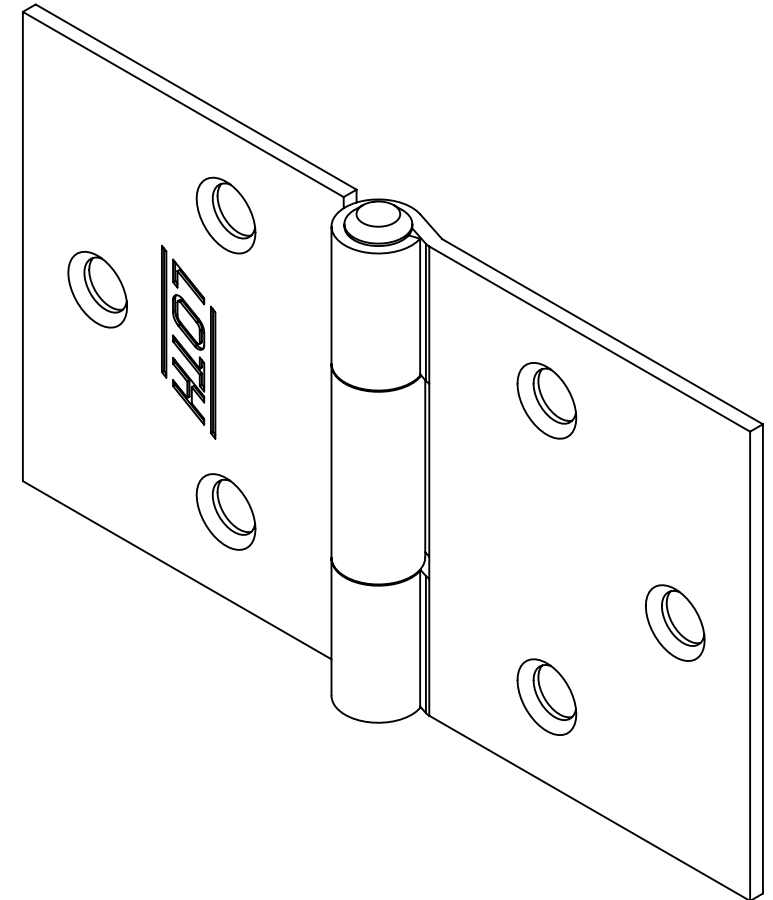

Metalúrgica Loth Ltda.

Cód. 3315

3315-Dobradica Quadrada 1,5

Material: AISI 1010

Peso: 29.64g

Dobradiça Quadrada 1,5

