

Código	Acabamento
24804	Zincado
34804	Bicromatizado
64804	Cromatizado Preto

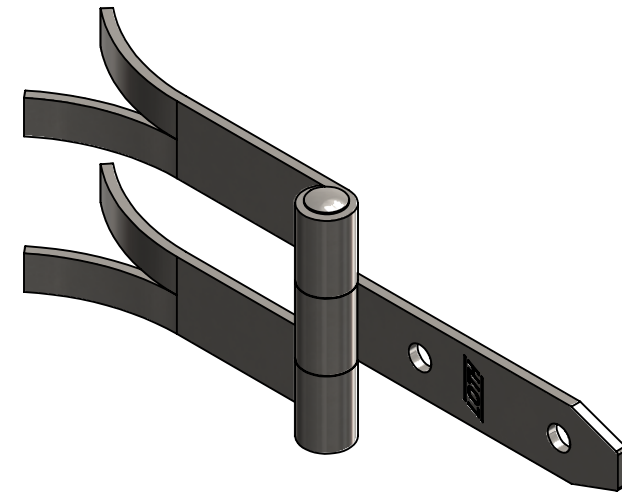
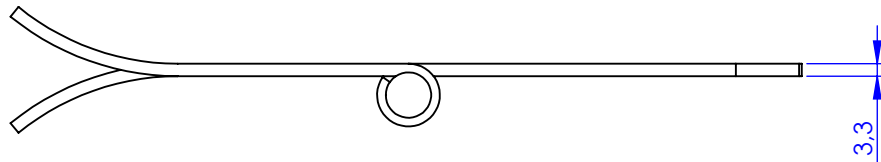
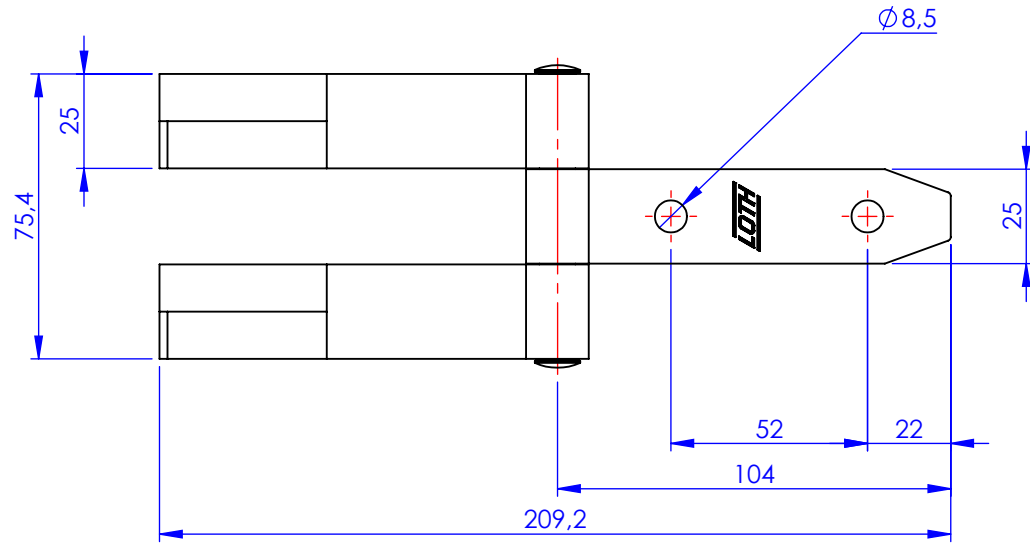

Metalúrgica Loth Ltda.

4804-Dobradica Portao Duas Hastes 4pol Chumbar

Cód. 4804

Material: AISI 1010
Peso: 315.34g

