

Código	Acabamento
3416	Pintado Epoxi Branco

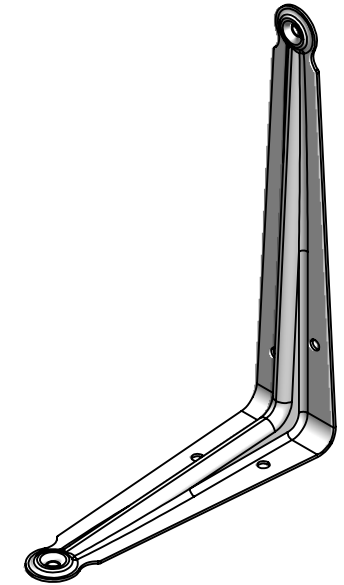
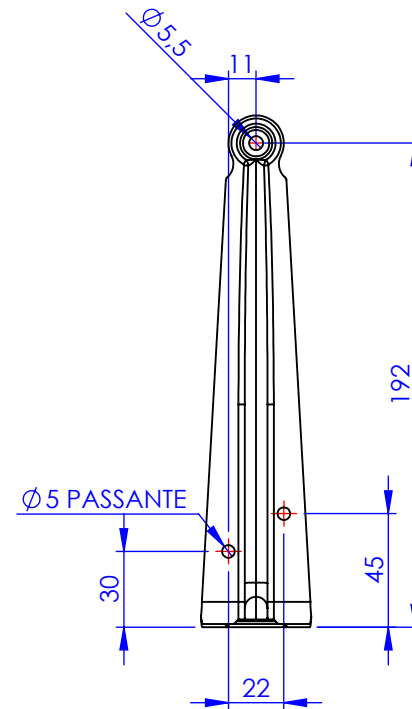
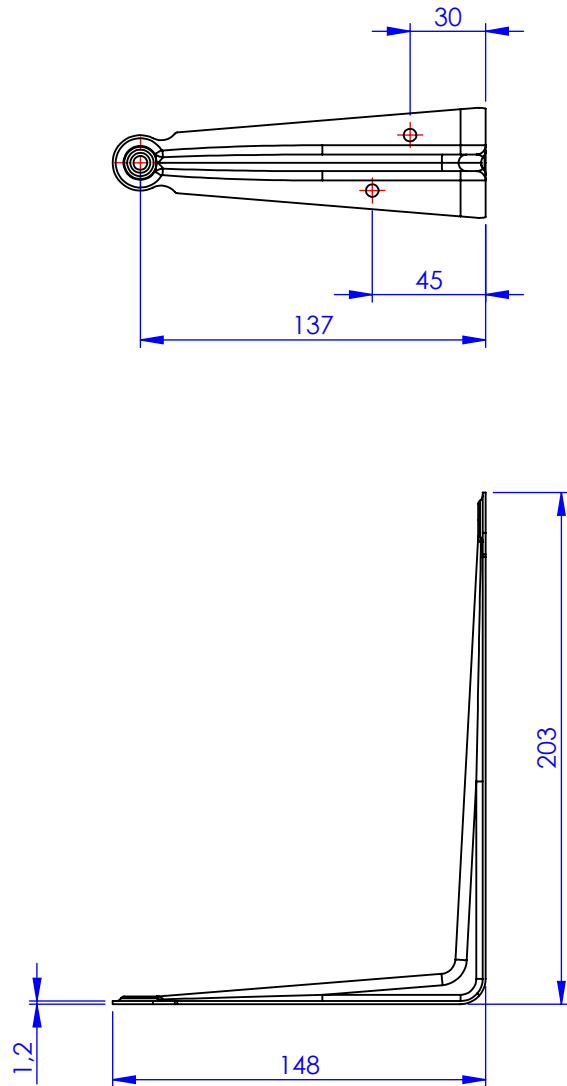

Metalúrgica Loth Ltda.

3416-Cantoneira Prateleira Loth 6x8

Cód. 3416

Material: AISI 1010
Peso: 124.44g

