

Código	Acabamento
3711	Pintado Epoxi Branco
23711	Zincado
33711	Bicromatizado
63711	Cromatizado Preto

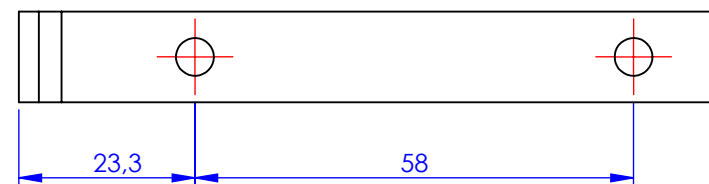
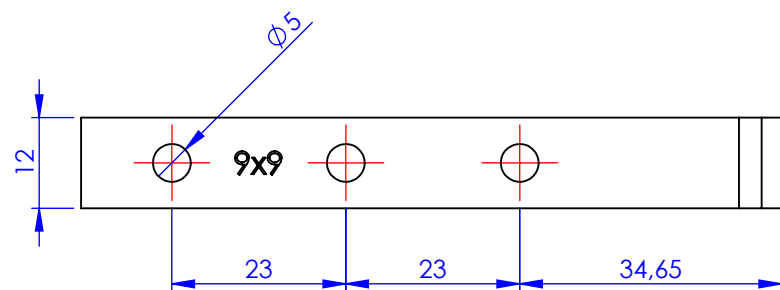
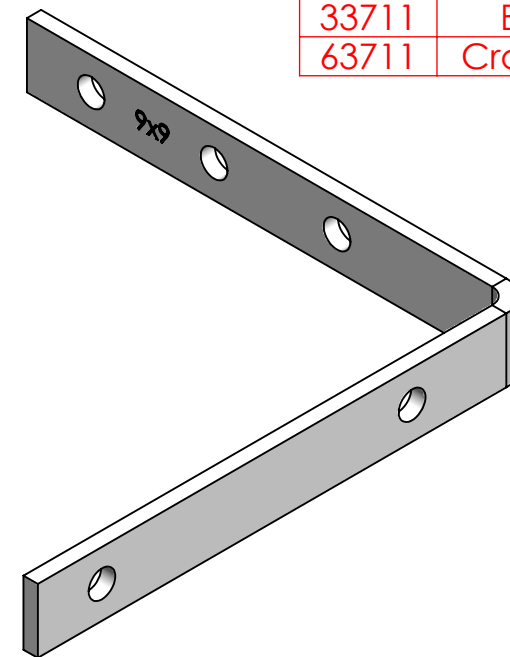
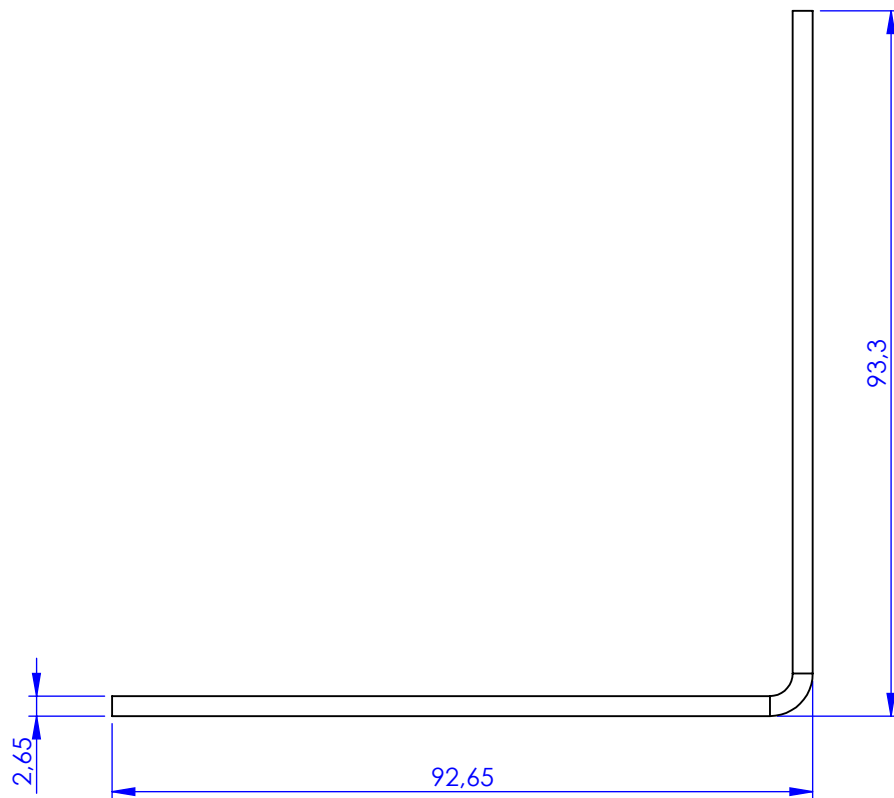

**Metalúrgica Loth Ltda.**

**3711-Cantoneira Cortina Tipo Leve 9x9**

Cód. 3711

Material: AISI 1010

Peso: 43.35g

