

Código	Acabamento
3706	Pintado Epoxi Branco
23706	Zincado
33706	Bicromatizado
63706	Cromatizado Preto

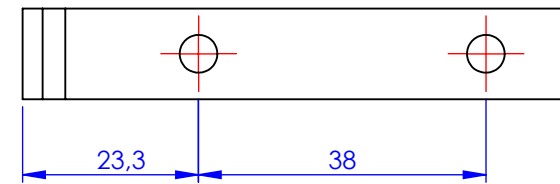
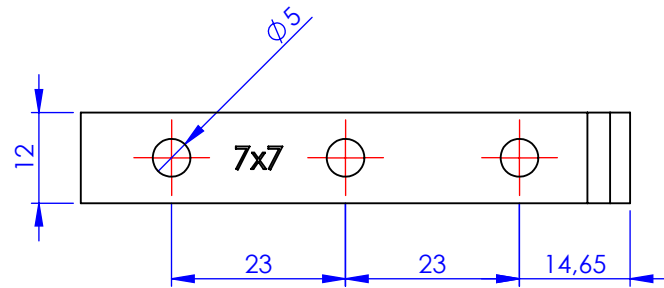
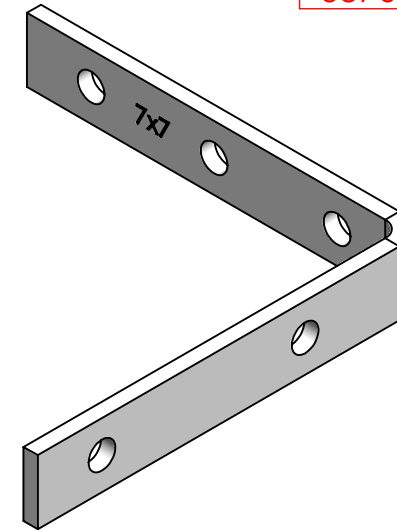
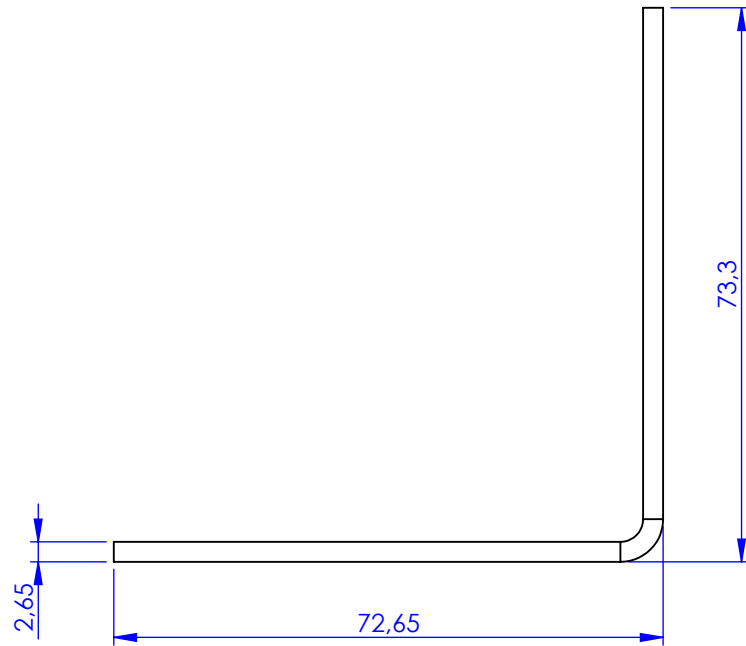

**Metalúrgica Loth Ltda.**

**3706-Cantoneira Cortina Tipo Leve 7x7**

Cód. 3706

Material: AISI 1010

Peso: 33.34g

