

Código	Acabamento
3703	Pintado Epoxi Branco
23703	Zincado
33703	Bicromatizado
63703	Cromatizado Preto

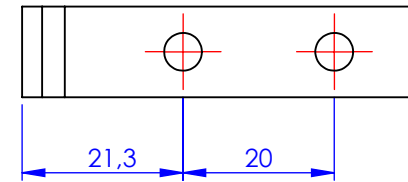
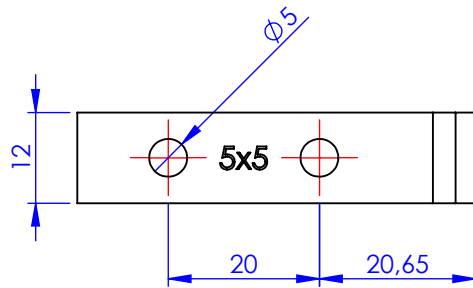
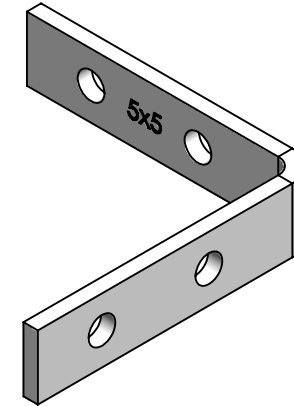
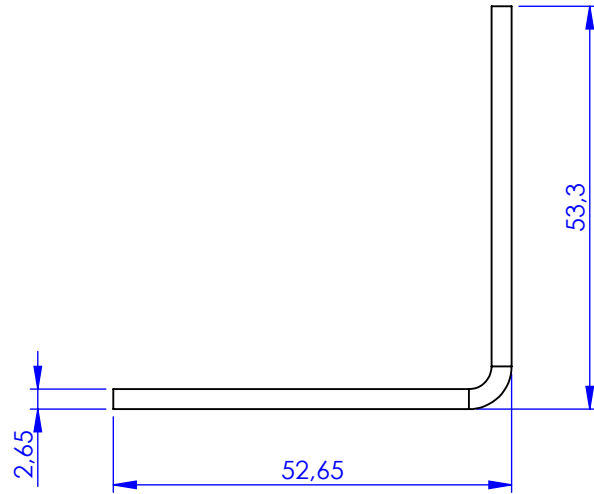

Metalúrgica Loth Ltda.

3703-Cantoneira Cortina Tipo Leve 5x5

Cód. 3703

Material: AISI 1010

Peso: 23.73g

