

Código	Acabamento
3702	Pintado Epoxi Branco
23702	Zincado
33702	Bicromatizado
63702	Cromatizado Preto

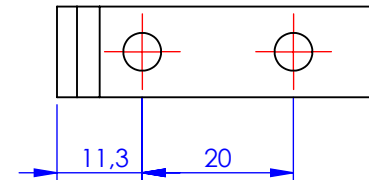
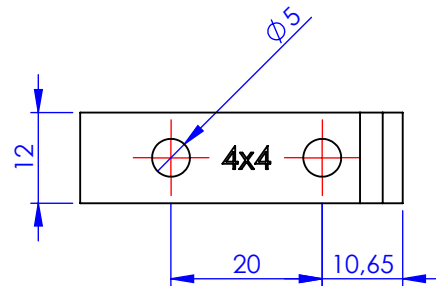
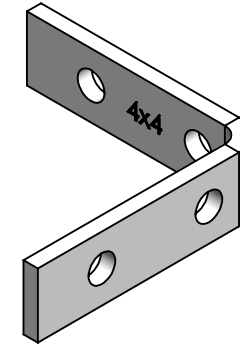
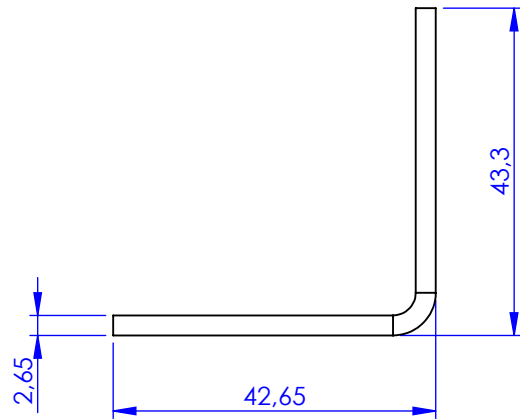

Metalúrgica Loth Ltda.

3702-Cantoneira Cortina Tipo Leve 4x4

Cód. 3702

Material: AISI 1010

Peso: 18.73g

