

Código	Acabamento
3429	Pintado Epoxi Branco
23429	Zincado
33429	Bicromatizado
63429	Cromatizado Preto

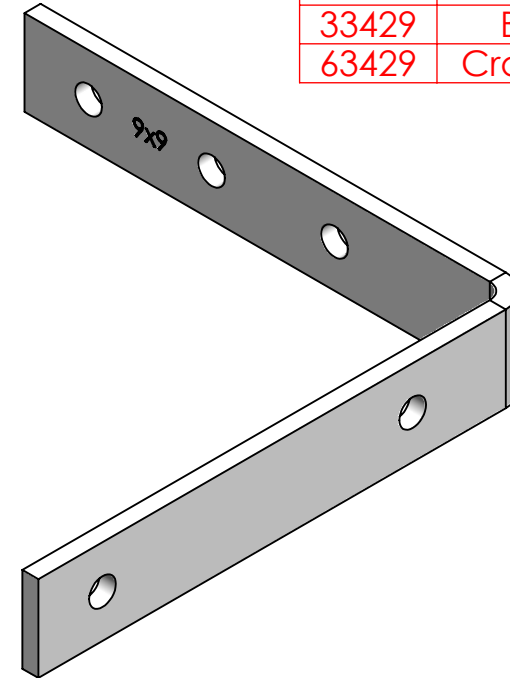

Metalúrgica Loth Ltda.

3429-Cantoneira Cortina 9x9

Cód. 3429

Material: AISI 1010

Peso: 66.23g

