

Código	Acabamento
3428	Pintado Epoxi Branco
23428	Zincado
33428	Bicromatizado
63428	Cromatizado Preto

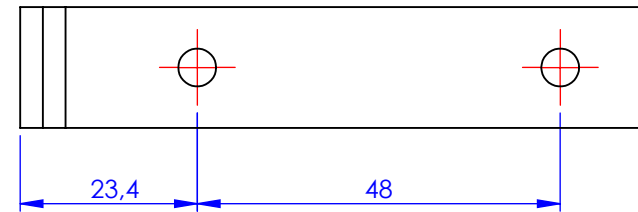
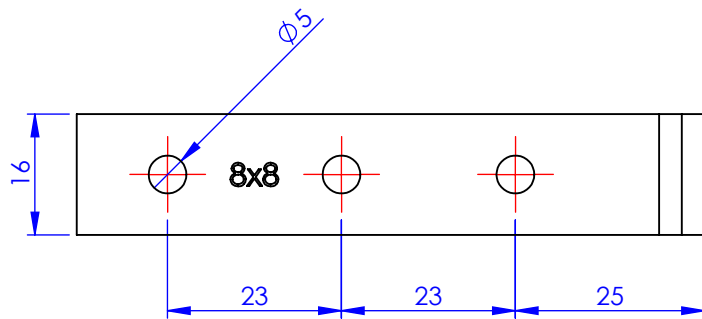
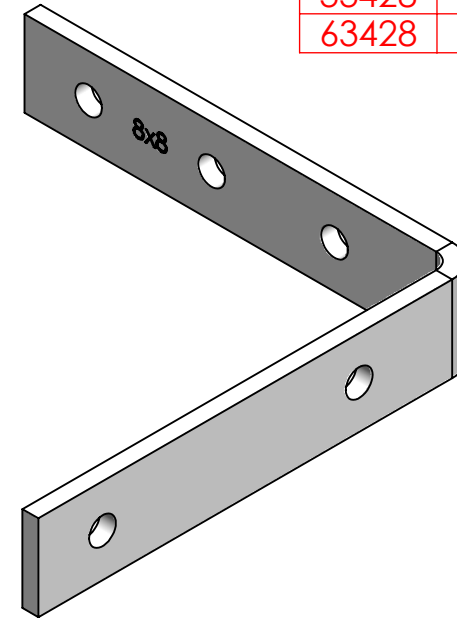
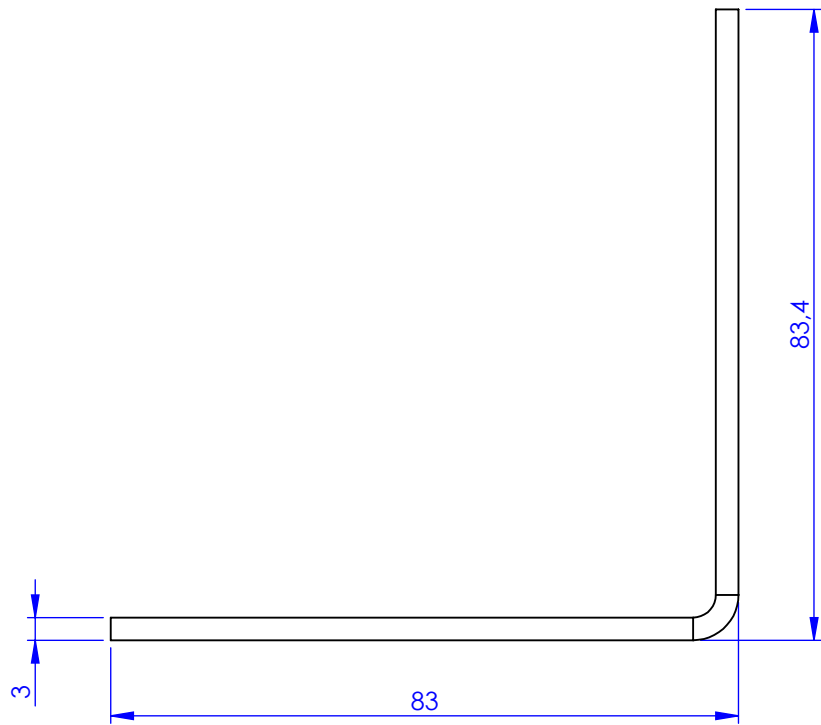

Metalúrgica Loth Ltda.

Cód. 3428

3428-Cantoneira Cortina 8x8

Material: AISI 1010

Peso: 58.67g

