

Código	Acabamento
3427	Pintado Epoxi Branco
23427	Zincado
33427	Bicromatizado
63427	Cromatizado Preto

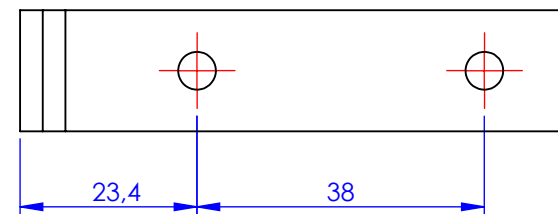
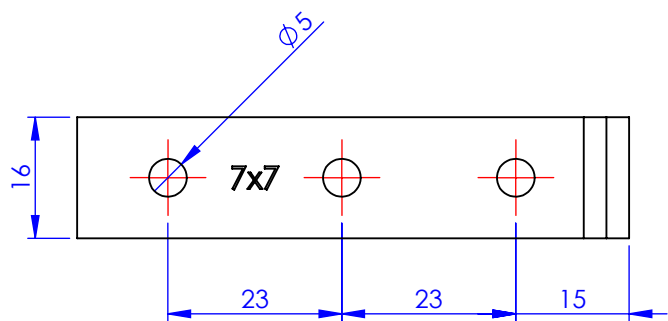
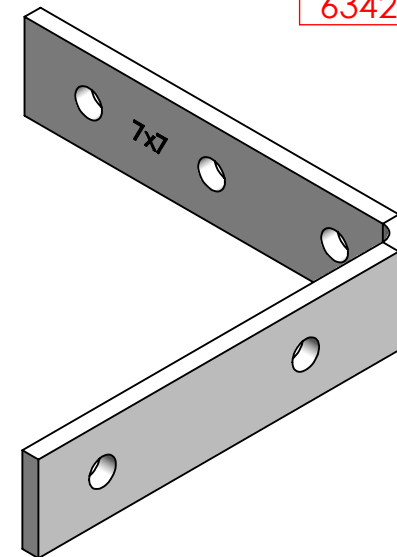
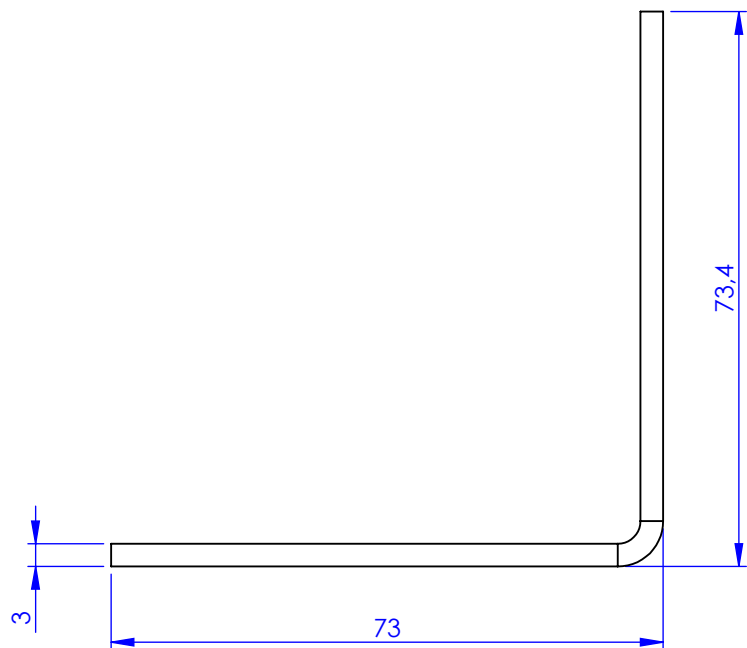

**Metalúrgica Loth Ltda.**

Cód. 3427

**3427-Cantoneira Cortina 7x7**

Material: AISI 1010

Peso: 51.12g

