

Código	Acabamento
3006	Pintado Epoxi Branco
23006	Zincado
33006	Bicromatizado
63006	Cromatizado Preto

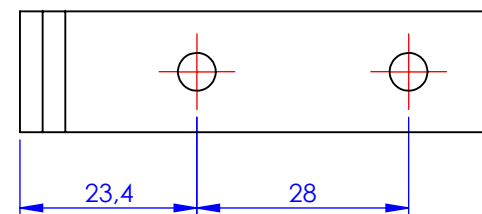
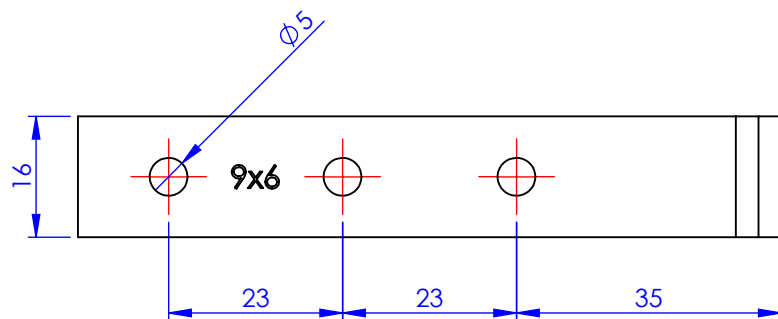
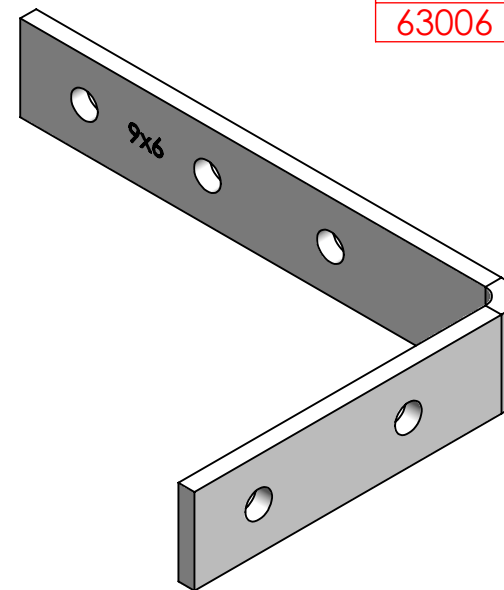
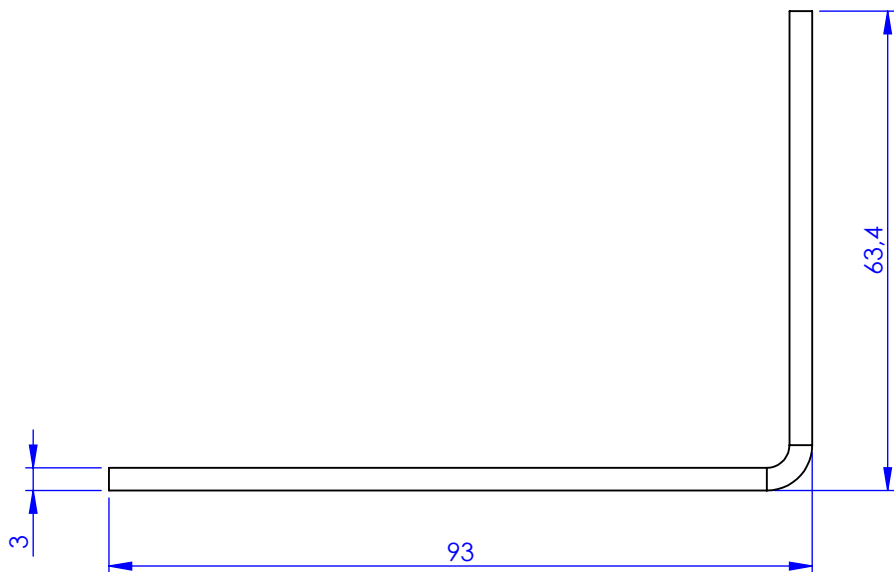

Metalúrgica Loth Ltda.	Cód.	3006	
	3006-Cantoneira Cortina 6x9	Material:	AISI 1010
		Peso:	54.89g
			