

Código	Acabamento
3426	Pintado Epoxi Branco
23426	Zincado
33426	Bicromatizado
63426	Cromatizado Preto

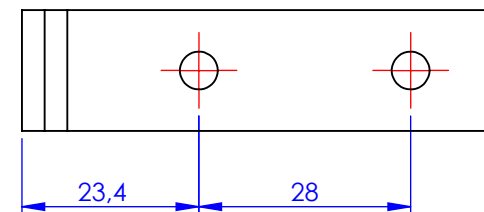
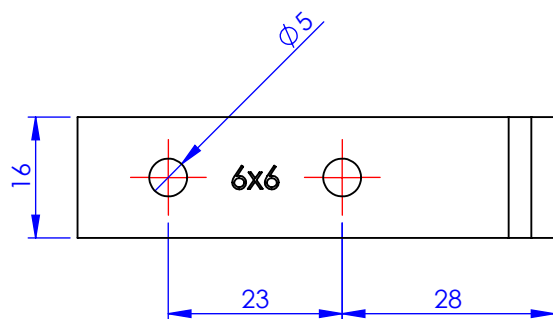
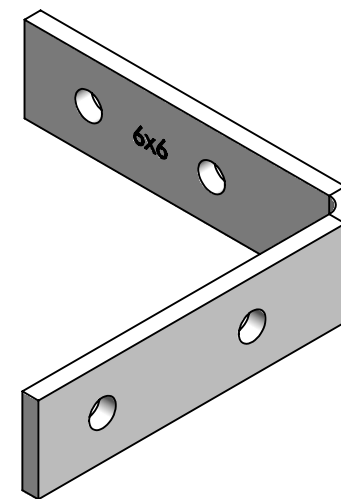
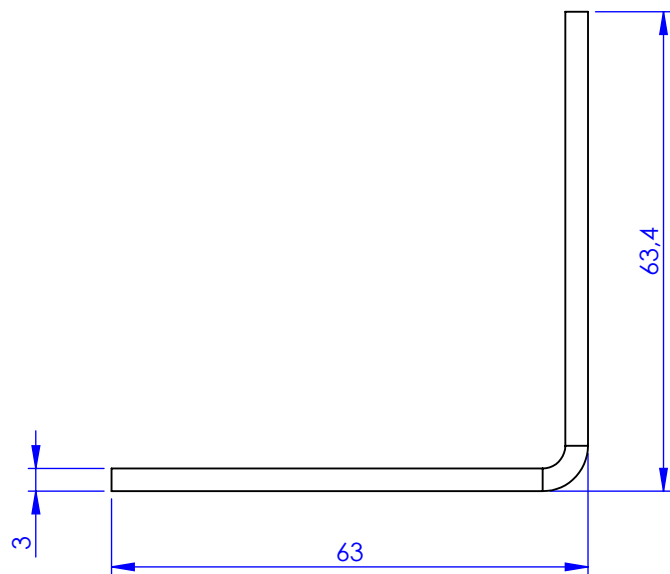

Metalúrgica Loth Ltda.

Cód. 3426

3426-Cantoneira Cortina 6x6

Material: AISI 1010

Peso: 44.02g

